





Technical data

Description:	Power distribution block PDB 490
Construction:	all-side fingersafe, modular system, bridgeable
Item no. :	082090-0-3

IEC Specific

Standards:	DIN EN 60947-7-1				
Nominal Voltage:	1000 V AC 1500 V DC				
Nominal current:	353 A Cu  490 A Cu 				
Terminal cross section:	Incoming	Cu			
	1 x	95 – 185 mm ² 70 – 150 mm ² M14 19 Nm 27 mm			round conductor Cu (solid wire and multi wire) stranded wire with ferrule allen screw (hexagonal socket) tightening torque stripping length
	1 x	24 x 10 mm M6 3 Nm 22 mm			flat conductor Cu allen screw (hexagonal socket) x 2 tightening torque stripping length
	Outgoing				
	2 x	4 – 35 mm ² 2,5 – 25 mm ² M8 2,5 Nm 18 mm			round conductor Cu (solid wire and multi wire) stranded wire with ferrule allen screw (hexagonal socket) tightening torque stripping length
	3 x	2,5 – 25 mm ² 1,5 – 16 mm ² M6 2 Nm 12 mm			round conductor Cu (solid wire and multi wire) stranded wire with ferrule allen screw (hexagonal socket) tightening torque stripping length
	4 x	1,5 – 16 mm ² 1,5 – 10 mm ² M6 2 Nm 12 mm			round conductor Cu (solid wire and multi wire) stranded wire with ferrule allen screw (hexagonal socket) tightening torque stripping length

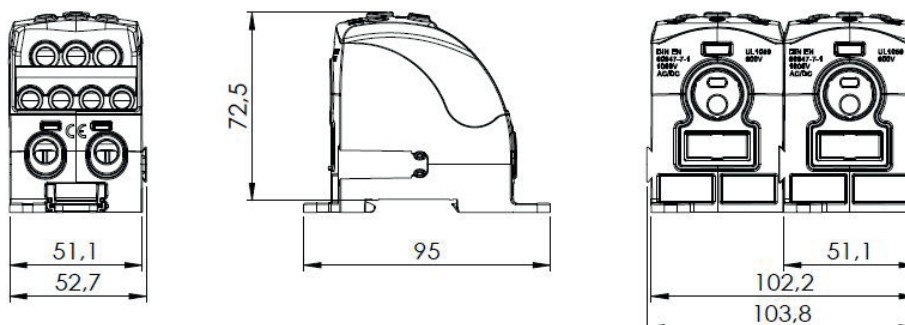

Remarks:	The product is compliant with the EC ROHS directives		
Materials:	Terminal body:	brass (CuZn39Pb2)	tin plated
	Basic housing:	PA 6 (Halogen-free)	
	Cover:	PC	
	Screws:	steel	Zn thick-film passivated
Flame resistance:	Self-extinguishing		
Mechanical data:	Dimensions:	width x height x depth (mm):	52,7 x 72,5 x 95



Technical data

Description:	Power distribution block PDB 490
Construction:	all-side fingersafe, modular system, bridgeable
Item no. :	082090-0-3

UL Specific

Standards:	UL-1059	UL-1059		
Nominal Voltage:	600 V AC	600 V AC		
Nominal current:	310 A Cu 	250 A Al 		
Terminal cross section:	Incoming	Cu	Al	
	1 x	000 – 350 AWG 00 – 300 AWG M14 25 Nm 27 mm	000 – 350 AWG 00 – 300 AWG M14 22,6 Nm 27 mm	round conductor Cu (solid wire and multi wire) stranded wire with ferrule allen screw (hexagonal socket) tightening torque stripping length
	1 x	24 x 10 mm M6 3 Nm 22 mm	- - - -	flat conductor Cu allen screw (hexagonal socket) x 2 tightening torque stripping length
	Outgoing			
	2 x	12 – 2 AWG 14 – 4 AWG M8 6 Nm 18 mm	6 – 2 AWG 6 – 4 AWG M8 11,3 Nm 18 mm	round conductor Cu (solid wire and multi wire) stranded wire with ferrule allen screw (hexagonal socket) tightening torque stripping length
	3 x	14 – 4 AWG 16 – 6 AWG M6 3 Nm 12 mm	6 – 4 AWG 6 AWG M6 5,1 Nm 12 mm	round conductor Cu (solid wire and multi wire) stranded wire with ferrule allen screw (hexagonal socket) tightening torque stripping length
	4 x	16 – 6 AWG 16 – 8 AWG M6 3 Nm 12 mm	6 AWG - M6 5,1 Nm 12 mm	round conductor Cu (solid wire and multi wire) stranded wire with ferrule allen screw (hexagonal socket) tightening torque stripping length

SCCR Rating:

Line	Load	Fuse Class						Amps, kA	Voltage, V
		J	T	RK1	RK5	G	CC		
300 - 2/0	4 - 14 Top	60	60	60	30	-	30	200	600
350 - 3/0	6 - 14 Middle 2 - 12 Bottom	-	-	-	-	60	-	100	600

Design

Basic housing colour – light grey RAL 7035

Part no.	Design	Cover colour	PU	GTIN (EAN)
082090-0-3	Universal	crystal clear	1	4051589209038