

## QTP-T/E 1X18,2X18

QUICKTRONIC PROFESSIONAL M | ECG for CFL



### Areas of application

- Emergency lighting systems acc. to EN 50172 / DIN VDE 0108-100
- Public buildings
- Sports halls and factories
- Suitable for luminaires of protection class I

### Product family benefits

- Long lamp life
- No adverse effect from frequent on/off switching
- Automatic restart after lamp replacement
- Perfect lamp start for applications with motion sensors
- Separate installations thanks to optional cable clamp for K2 and K3 casings
- VDE/VDE EMC certified system

### Product family features

- Supply voltage: 220...240 V
- Line voltage: 198...264 V
- Line frequency: 0 Hz | 50 Hz | 60 Hz
- Lamp start with optimum filament preheating
- Energy Efficiency Index EEI: A2
- Automatic shutdown of defective lamps and at end of life (EoL T.2)
- Lamp operation: to EN 60929
- Safety: to EN 61347-2-3

# Product datasheet

## Technical data

### Electrical data

Input voltage AC	198...264 V
Nominal voltage	220...240 V
Mains frequency	50...60 Hz
Input voltage DC	176...264 V
Operating frequency	40...50 kHz
Max. ECG no. on circuit breaker 10 A (B)	17 <sup>1)</sup>
Max. ECG no. on circuit breaker 16 A (B)	28 <sup>1)</sup>

<sup>1)</sup> Type B

### Light technical data

Starting time	1.0 s
---------------	-------

### Dimensions & weight

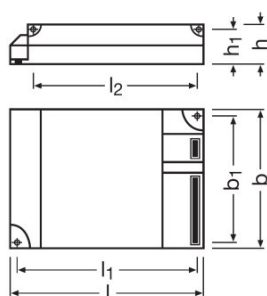

Length	103.0 mm
Width	67.0 mm
Height	31.0 mm
Mounting hole spacing, length	94.0 mm
Product weight	149.00 g
Cable cross-section, output side	0.5...1.5 mm <sup>2</sup>
Cable cross-section, input side	0.5...1.5 mm <sup>2</sup>

### Temperatures & operating conditions

Ambient temperature range	-20...+50 °C
Permitted rel. humidity during operation	5...85 % <sup>1)</sup>

<sup>1)</sup> Maximum 56 days/year at 85 %

## Product datasheet

### Lifespan

ECG lifetime	50000 h <sup>1)</sup>
--------------	-----------------------

<sup>1)</sup> At  $T_{case} = 75^{\circ}\text{C}$  at  $T_{c\_point}$  / 10% failure rate

### Expected Lifetime

Product name	Lamp group				
QTP-T/E 1X18,2X18	DULUX T/E 18 W	ECG ambient temperature [ta]	40	50	60
		Temperature at tc-point [°C]	55	65	70
		Lifetime [h]	100000	100000	60000

### Additional product data

Suitable for lamp power (1 lamp)	18 W
Suitable for lamp power (2 lamps)	18 W

### Capabilities

Suitable for fixtures with prot. class	I / II
End of lamp life safety shutdown	EOL T.2
Max. cable length to lamp/LED module	2.0 m / 1.0 m
Dimmable	No

### Certificates & standards

Approval marks – approval	VDE / VDE-EMC / ENEC 10 / GOST / RCM
EEL – Energy Label	A2 BAT
Standards	Acc. to EN 61347-2-3/Acc. to EN 60929/Acc. to EN 55015:2006 + A1:2007/Acc. to EN 61000-3-2/Acc. to EN 61547
Protection class	III
Type of protection	IP20

### Logistical data

Commodity code	850410809000
----------------	--------------

## Product datasheet

### Wiring Diagram

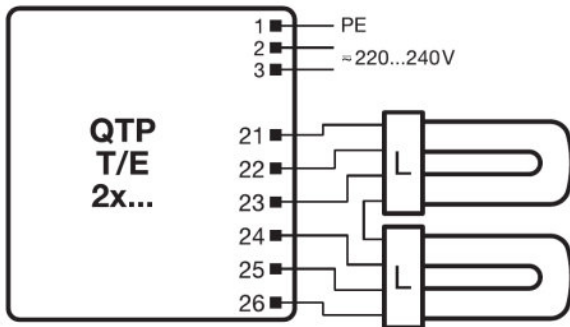



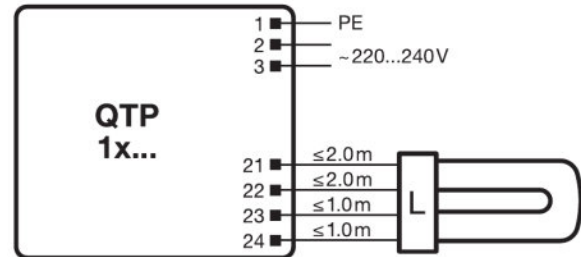



Wiring diagram



Wiring diagram

### Download Data

File
 Product Datasheet 502688_ECG lifetime - QUICKTRONIC non DIM
 Certificates 334954_ENEC-Marks approval
 Certificates 334956_EMC-Marks approval &#150; QTP-M
 Certificates 335169_Manufacturer's declaration &#150; LampECG combinations: Frequent switching
 Certificates 504181_VDE-EMC-Certificate QTP DL_TE
 Declarations of conformity 334769_CE conformity
 Operating instructions 596657_EAC QTP-DE + QTP-TE

### Logistical Data

## Product datasheet

Product code	Product description	Packaging unit (Pieces/Unit)	Dimensions (length x width x height)	Volume	Gross weight
4008321537065	QTP-T/E 1X18,2X18	Shipping carton box 20	360 mm x 101 mm x 230 mm	8.36 dm <sup>3</sup>	3266.00 g

The mentioned product code describes the smallest quantity unit which can be ordered. One shipping unit can contain one or more single products. When placing an order, for the quantity please enter single or multiples of a shipping unit.

---

### Disclaimer

Subject to change without notice. Errors and omission excepted. Always make sure to use the most recent release.

## QTP-T/E 1X18,2X18

QUICKTRONIC PROFESSIONAL M | ECG for CFL

Product name	Lamp group	Nominal current	Nominal wattage + Power loss	Luminous flux at 25 °C	Number of lighting outlets
QTP-T/E 1X18,2X18	DULUX D/E 18 W	0.16 A	36.00 W	1200 lm	2
	DULUX T/E 18 W	0.16 A	36.00 W	2*2200 lm	2
	DULUX D/E 18 W	0.09 A	19.00 W	1*1200 lm	1
	DULUX T/E 18 W	0.09 A	19.00 W	1*1200 lm	1