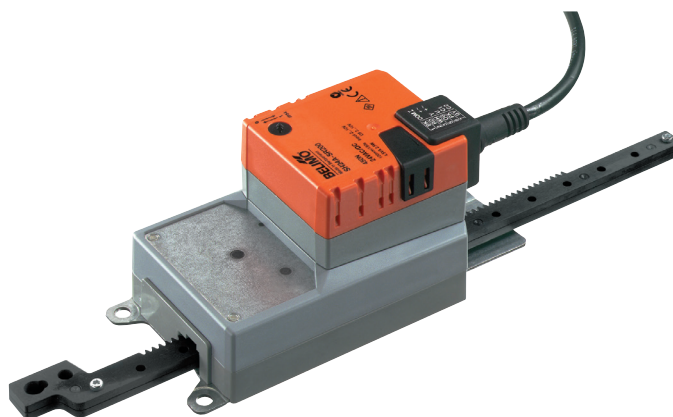

Modulating linear actuator for adjusting dampers and slide valves in technical building installations

- Air damper size up to approx. 3 m<sup>2</sup>
- Actuating force 450 N
- Nominal voltage AC/DC 24 V
- Control Modulating DC (0)2...10 V
- Position feedback DC 2...10 V
- Length of Stroke Max. 200 mm, fixed setting

**Technical data**

<b>Electrical data</b>	Nominal voltage	AC/DC 24 V
	Nominal voltage frequency	50/60 Hz
	Nominal voltage range	AC 19.2...28.8 V / DC 19.2...28.8 V
	Power consumption in operation	2.5 W
	Power consumption in rest position	0.4 W
	Power consumption for wire sizing	4.5 VA
	Connection supply / control	Cable 1 m, 3 x 0.75 mm <sup>2</sup>
	Parallel operation	Yes (note the performance data)
	<b>Functional data</b>	Actuating force motor
Positioning signal Y		DC 0...10 V
Positioning signal Y note		Input impedance 100 kΩ
Operating range Y		DC 2...10 V
Position feedback U		DC 2...10 V
Position feedback U note		Max. 1 mA
Position accuracy		±5%
Direction of motion motor		Selectable with switch
Direction of motion note		Y = 0 V: with switch 0 (extended) / 1 (retracted)
Manual override		Gear disengagement with push-button, can be locked
Length of Stroke		Max. 200 mm, fixed setting
Running time motor		150 s / 100 mm
Sound power level motor		52 dB(A)
<b>Safety</b>	Protection class IEC/EN	III Safety extra-low voltage
	Protection class UL	UL Class 2 Supply
	Degree of protection IEC/EN	IP54
	Degree of protection NEMA/UL	NEMA 2, UL Enclosure Type 2
	EMC	CE according to 2004/108/EC
	Certification IEC/EN	IEC/EN 60730-1 and IEC/EN 60730-2-14
	Certification UL	cULus according to UL 60730-1A, UL 60730-2-14 and CAN/CSA E60730-1:02
	Mode of operation	Type 1
	Rated impulse voltage supply / control	0.8 kV
	Control pollution degree	3
	Ambient temperature	-30...50 °C
	Non-operating temperature	-40...80 °C
	Ambient humidity	95% r.h., non-condensing
Maintenance	Maintenance-free	
<b>Weight</b>	Weight	1.2 kg

**Safety notes**

- The device must not be used outside the specified field of application, especially not in aircraft or in any other airborne means of transport.
- Outdoor application: only possible in case that no (sea)water, snow, ice, insolation or aggressive gases interfere directly with the actuator and that is ensured that the ambient conditions remain at any time within the thresholds according to the data sheet.

## Safety notes

- Only authorised specialists may carry out installation. All applicable legal or institutional installation regulations must be complied during installation.
- The device may only be opened at the manufacturer's site. It does not contain any parts that can be replaced or repaired by the user.
- Cables must not be removed from the device.
- The gear rod and the mechanical end stops must not be removed.
- The rotary supports and coupling pieces available as accessories must always be used if transverse forces are likely. In addition, the actuator must not be tightly bolted to the application. It must remain movable via the rotary support (refer to «Assembly notes»).
- If the actuator is exposed to severely contaminated ambient air, appropriate precautions must be taken on the system side. Excessive deposits of dust, soot etc. can prevent the gear rod from being extended and retracted correctly.
- If not installed horizontally, the gear disengagement pushbutton may only be actuated when there is no pressure on the gear rod.
- To calculate the actuating force required for air dampers and slide valves, the specifications supplied by the damper manufacturers concerning the cross section, the design, the installation site and the ventilation conditions must be observed.
- If a rotary support and/or coupling piece is used, actuation force losses are to be expected.
- The device contains electrical and electronic components and must not be disposed of as household refuse. All locally valid regulations and requirements must be observed.

## Product features

<b>Mode of operation</b>	The actuator is connected with a standard modulating signal of DC 0...10V and drives to the position defined by the positioning signal. Measuring voltage U serves for the electrical display of the damper position 0...100% and as slave control signal for other actuators.
<b>Simple direct mounting</b>	The actuator can be directly connected with the application using the enclosed screws. The head of the gear rod is connected to the moving part of the ventilating application individually on the mounting side or with the Z-KS1 coupling piece provided for this purpose.
<b>Manual override</b>	Manual override with push-button possible (the gear is disengaged for as long as the button is pressed or remains locked).
<b>High functional reliability</b>	The actuator is overload protected, requires no limit switches and automatically stops when the end stop is reached.

## Accessories

	Description	Type
<b>Electrical accessories</b>	Digital position indicator for front-panel mounting, 0...99%, front mass 72 x 72 mm	ZAD24
	Range controller for wall mounting, adjustable electron. Min./max. angle of rotation limitation	SBG24
	Positioner for wall mounting, range 0...100%	SGA24
	Positioner in a conduit box, range 0...100%	SGE24
	Positioner for front-panel mounting, range 0...100%	SGF24
	Positioner for wall mounting, range 0...100%	CRP24-B1
	Description	Type
<b>Mechanical accessories</b>	End stop set for SH	Z-AS1
	Rotary support for compensation of transverse forces	Z-DS1
	Coupling piece M8 for SH, galvanised steel	Z-KS1

## Electrical installation



### Notes

- Connection via safety isolating transformer.
- Parallel connection of other actuators possible. Observe the performance data.

## Wiring diagrams

AC/DC 24 V, modulating

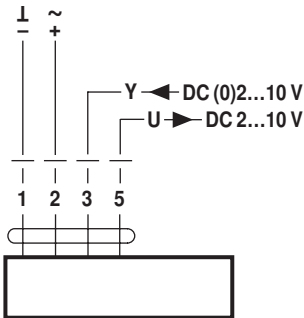

## Installation notes



### Notes

- If a rotary support and/or coupling piece is used, losses in the actuation force losses are to be expected.

### Applications without transverse force

The linear actuator is screwed directly to the housing at three points. Afterwards, the head of the gear rod is fastened to the moving part of the ventilation application (e.g. damper or slide valve).

### Applications with transverse forces

The coupling piece with the internal thread (Z-KS1) is connected to the head of the gear rod. The rotary support (Z-DS1) is screwed to the ventilation application. Afterwards, the linear actuator is screwed to the previously mounted rotary support with the enclosed screw. Afterwards, the coupling piece, which is mounted to the head of the gear rod, is attached to the moving part of the ventilating application (e.g. damper or slide valve). The transverse forces can be compensated for to a certain limit with the rotary support and/or coupling piece. The maximum permissible swivel angle of the rotary support and coupling piece is 10° (angle), laterally and upwards.

## Dimensions [mm]

### Dimensional drawings

