

THORN

Rivers

Distinctive appearance and striking performance



AMAZON
THAMES
SEINE
DANUBE
LOIRE



Rivers

Rivers is a unique collection of 5 contemporary luminaire ranges, including wall and ceiling mounted versions with each range designed to offer distinctive appearance and striking performance



The Rivers range satisfies the increasing demand for secondary lighting systems to provide visual relief. The distinctive product designs add a modern touch and enhance the lit environment. This extensive collection caters for all solutions, providing choice and flexibility

- A range of unique diffusers in a variety of materials (glass, polycarbonate) and finishes (opal, prismatic)
- Striking bezel options – visor and grille
- A variety of colours (white, black, silver, satin chrome, anthracite) and round and square shapes
- Ideal for use in many applications including entrance hall, receptions, stairwells, corridors, circulation routes, rest areas, and building surrounds
- Large choice of lamp and gear variants

Rivers

The collection incorporates many features which simplify the installation process also making the product easily accessible for maintenance



1. The Quick Fix Wall and Ceiling Bracket (QFB) simplifies installation to make it quick and easy, as the bracket can be pre-wired and mounted, without having to install the complete luminaire.
2. The unique 'light box' plug and play concept provides protection for the luminaire during the installation and ensures quick connection to the QFB
3. The QFB has been designed with a locking device, to allow the light box to be easily removed from the QFB for safe maintenance (electrically disconnected).

A simple fastening mechanism allows easy access into the light box for maintenance.



1.



2.



3.



AMAZON
THAMES
SEINE
DANUBE
LOIRE



Amazon has a striking contemporary form, created by twin structural bridges between the elements of the cast aluminium bezel. The diffuser is encircled and spills light onto the mounting surface in a directional halo.

Applications

Amazon is ideal to coordinate exterior (IP65) building surrounds with interior entrance halls or circulation areas.



- Aluminium body providing strength and rigidity
- A choice of two sizes in a circular or square design
- Striking opal polycarbonate diffuser
- Floating halo lighting effect
- Die-cast aluminium bezel available in white, silver or anthracite, to suit application
- Integral 3 hour maintained emergency versions, suitable for escape routes
- Large choice of compact fluorescent and T5 circular lamps
- Available with Electronic and Electronic Digital Dimming ballast
- Quick Fix Bracket supplied for safe and quick installation

Lamps

- ☛ 9W, TC-SEL (FSD) compact fluorescent. Cap: 2G7
- ☛ 18W, TC-DEL (FSD) compact fluorescent. Cap: G24q-2
- ☛ 26W, TC-DEL (FSQ) compact fluorescent. Cap: G24q-3
- ☛ 16, 28, 38W, TC-DDEL (FSS) compact fluorescent. Cap: GR10q
- 40, 55W, T16-R (FSC) circular fluorescent. Cap: 2GX13

Materials/Finish

Body: die-cast aluminium
 Bezel: die-cast aluminium, silver, anthracite, and white finish
 Diffuser: opal polycarbonate

Installation/Mounting

Suitable for surface mounting on wall or ceiling for both interior and exterior use. 'Quick Fix Bracket' (QFB) screw fixed onto mounting surface by 4 oblong holes (4.5mm x 10mm). Main connection via 6 way connecting block. 'Light Box' direct and auto-connected to the QFB. For loop wiring a double 20mm cable entry holes to rear of QFB.

Standards

Designed and manufactured to comply with EN60598, EN55015: 2000 (EMC). Emergency version with EN60598-2.22.
 ⚡ Class1 Electrical
 ⚡⚡⚡ IP65 ⚡⚡ CE

Specification

To specify state:
 Striking circular or square luminaire for 9W/TC-SEL, 18, 26W/TC-DEL, 16, 28, 38W/TC-DDEL compact fluorescent, 40, 55W/T16-R circular fluorescent lamps with die-cast aluminium 'floating Halo' and double ring mounting and twin bridge with opal polycarbonate diffuser mounted to a die-cast aluminium body, with lamp and electronic, electronic dimmable, integral emergency gear, connected to Quick Fix Wall and Ceiling Bracket.
 As Thorn Amazon.



Silver



Anthracite

AMAZON
THAMES
SEINE
DANUBE
LOIRE



Thames has a concave diffuser face and tapered sides, which create a unique and distinctive appearance. Backlighting generates a floating halo effect.

Applications

Thames circular and square shaped design together with high quality finish offers over 80 variants to suit interior corridors and entrance hall applications.

The floating halo light effect reduces light contrast between the luminaire and the mounting surface to improve lighting comfort.



- Aluminium body providing strength and rigidity
- A choice of two sizes in a circular or square design
- Characteristic concave opal polycarbonate diffuser
- Floating halo lighting effect
- Metallic bezel available in white, silver or satin chrome, to suit application
- Integral 3 hour maintained emergency versions, suitable for escape routes
- Large choice of compact fluorescent and T5 Circular lamps
- Available with Magnetic, Electronic and Electronic Digital Dimming ballast
- Quick Fix Bracket supplied for safe and quick installation

Lamps

- ☐ 9W, TC-S (FSD) compact fluorescent. Cap: G23
- ☐ 9W, TC-SEL (FSD) compact fluorescent. Cap: 2G7
- ☐ 18W, TC-DEL (FSD) compact fluorescent. Cap: G24q-2
- ☐ 26W, TC-DEL (FSQ) compact fluorescent. Cap: G24q-3
- ☐ 16W, TC-DD (FSS) compact fluorescent. Cap: GR8
- ☐ 16, 28, 38W, TC-DDEL (FSS) compact fluorescent. Cap: GR10q
- 40, 55W, T16-R (FSC) circular fluorescent. Cap: 2GX13

Materials/Finish

Body: die-cast aluminium
 Bezel: steel, silver, satin chrome and white finish
 Diffuser: opal polycarbonate

Installation/Mounting

Suitable for surface mounting on wall or ceiling for both interior or exterior use. 'Quick Fix Bracket' (QFB) screw fixed onto mounting surface by 4 oblong holes (4.5mm x 10mm). Main connection via 6 way connecting block. 'Light Box' direct and auto-connected to the QFB. For loop wiring a double 20mm cable entry holes to rear of QFB.

Standards

Designed and manufactured to comply with EN60598, EN55015: 2000 (EMC). Emergency version with EN60598 (2.22).
 ⚡ Class 1 Electrical
 ⚠ IP44 ⚡ CE

Specification

To Specify state:
 Unique and distinctive circular or square luminaire for 9W/TC-S, 9W/TC-SEL, 18, 26W/TC-DEL, 16/TC-DD, 16, 28, 38W/TC-DDEL compact fluorescent, 40, 55W/T16-R circular fluorescent with an acute angular steel bezel 'floating Halo' with concave opal polycarbonate diffuser mounted on a die-cast aluminium body, with lamp and electronic, electronic dimmable, integral emergency gear, connected to Quick Fix Wall and Ceiling Bracket.
 As Thorn Thames.



White



Satin Chrome



AMAZON
THAMES
SEINE
DANUBE
LOIRE



Seine has clean edges combined with a smooth fronted diffuser, designed in glass for a classical appearance, with a contemporary feel.

Applications

The unique 'cushion' design diffuses an evenly distributed comfortable lighting effect and has a modern appearance when unlit for executive offices, corridors and meeting rooms, also hotel receptions and circulation areas.



- Aluminium body providing strength and rigidity
- A choice of two sizes in a circular or square design
- Distinctive 'cushion' shape opal glass diffuser providing smooth diffused light
- Aesthetic appeal both lit and unlit
- Unique floating halo lighting effect
- Integral 3 hour maintained emergency versions, suitable for escape routes
- Large choice of incandescent, compact fluorescent and T5 circular lamps
- Available with Electronic and Electronic Digital Dimming ballast
- Quick Fix Bracket supplied for safe and quick installation

Lamps

- 40, 60W, A/c (IA/c) Edison screw incandescent. Cap: E27
- 9W, TC-SEL (FSD) compact fluorescent. Cap: 2G7
- 18W, TC-DEL (FSD) compact fluorescent. Cap: G24q-2
- 26W, TC-DEL (FSQ) compact fluorescent. Cap: G24q-3
- 16, 28, 38W, TC-DDEL (FSS) compact fluorescent. Cap: GR10q
- 40, 55W, T16-R (FSC) circular fluorescent. Cap: 2GX13

Materials/Finish

Body: die-cast aluminium with polycarbonate fixation
 Diffuser: opal glass

Installation/Mounting

Suitable for surface mounting on wall or ceiling for interior use. 'Quick Fix Bracket' (QFB) screw fixed onto mounting surface by 4 oblong holes (4.5mm x 10mm). Main connection via 6 way connecting block. 'Light Box' direct and auto-connected to the QFB. For loop wiring a double 20mm cable entry holes to rear of QFB.

Standards

Designed and manufactured to comply with EN60598, EN55015:2000 (EMC). Emergency version with EN60598-2.22.
 Ⓛ Class1 Electrical. IP20 

Specification

To specify state: Classic circular or square luminaire for 40, 60W/A/c Edison screw incandescent, 9W/TC-SEL, 18, 26W/TC-DEL, 16, 28, 38W/TC-DDEL compact fluorescent, 40, 55W/T16-R circular fluorescent lamps with 'Floating curved cushion' backlighting 'Halo', opal glass diffuser with lamp and electronic, electronic dimmable, integral emergency gear, connected to Quick Fix Wall and Ceiling Bracket. As Thorn Seine.



AMAZON
THAMES
SEINE
DANUBE
LOIRE

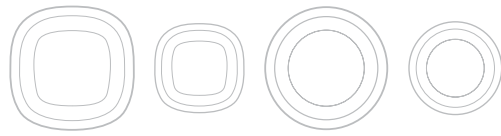

Danube utilises a flat front diffuser and bold flared sides to create a low profile luminaire. A range of versatile overlay bezels can alter the character to suit a wide range of environments.

Applications

The 250 Danube variants cover the widest range of applications from interior ancillary rooms (prismatic diffuser) and public circulation areas to building surrounds using the same product family differentiated by the shape (round or square), the bezel or the colour.



- A choice of two sizes in a circular or square design
- Flat fronted opal or clear prismatic polycarbonate diffuser
- Available in black or white to suit application
- Grille and visor versions available for aesthetic appearance
- Integral 3 hour maintained emergency versions, suitable for escape routes
- Large choice of compact fluorescent and T5 Circular lamps
- Available with Magnetic, Electronic and Electronic Digital Dimming ballast (Digital dimming versions available to order)
- IP65 for exterior installations
- Quick Fix Bracket supplied for safe and quick installation

Lamps

- ☐ 9W, TC-S (FSD) compact fluorescent. Cap: G23
- ☐ 9W, TC-SEL (FSD) compact fluorescent. Cap: 2G7
- ☐ 18W, TC-D (FSD) compact fluorescent. Cap: G24d-2
- ☐ 18W, TC-DEL (FSD) compact fluorescent. Cap: G24q-2
- ☐ 26W, TC-D (FSQ) compact fluorescent. Cap: G24d-3
- ☐ 26W, TC-DEL (FSQ) compact fluorescent. Cap: G24q-3
- ☐ 16, 28W, TC-DD (FSS) compact fluorescent. Cap: GR8
- ☐ 16, 28, 38W, TC-DDEL (FSS) compact fluorescent. Cap: GR10q
- 40W, T16-R (FSC) circular fluorescent. Cap: 2GX13

Materials/Finish

Body: polycarbonate
 Diffuser: opal polycarbonate or clear prismatic polycarbonate
 Bezel, visor and grille: polycarbonate, white or black finish

Installation/Mounting

Suitable for surface mounting on wall or ceiling for both interior and exterior use. 'Quick Fix Bracket' (QFB) screw fixed onto mounting surface by 4 oblong holes (4.5mm x 10mm). Main connection via 6 way connecting block. 'Light Box' direct and auto-connected to the QFB. For loop wiring a double 20mm cable entry holes to rear of QFB.

Standards

Designed and manufactured to comply with EN60598, EN55015: 2000 (EMC). Emergency version with EN60598-2.22.
 Ⓢ Class I Electrical – All electronic versions
 ☐ Class II Electrical – Incandescent and magnetic versions
 ⚡ IP65 Ⓢ CE

Specification

To specify state:
 Bold and versatile circular or square luminaire for 9W/TC-S, 9W/TC-SEL, 18, 26W/TC-D, 18, 26W/TC-DEL, 16, 28W/TC-DD, 16, 28, 38W/TC-DDEL, compact fluorescent, 40W/T16-R circular fluorescent lamps with polycarbonate body, 'flat' opal and prismatic diffuser with standard, grille or visor bezels in colour with lamp, magnetic, electronic, electronic dimmable and integral emergency gear, connected to Quick Fix Wall and Ceiling Bracket. As Thorn Danube.



AMAZON
THAMES
SEINE
DANUBE
LOIRE



Loire has a fresh design with a contemporary feel, the diffusers are in glass or polycarbonate. While Loire has a subtle bezel, it can be given a more striking appearance by way of bold grille and visor options.

Applications

A secure fitting using tamper resistant screws for public interior and exterior (IP65) circulation areas including stairwells, corridors and store rooms.



- Available in two sizes in a circular design, to suit application
- Contemporary dome shape opal polycarbonate or glass diffuser
- Available in black or white to suit environment
- Grille and visor versions available for an aesthetic appearance
- Integral 3 hour maintained emergency versions, suitable for escape routes
- Large choice of incandescent, compact fluorescent and T5 circular lamps
- Available with Magnetic and Electronic ballast (Digital dimming versions available to order)
- IP65 for exterior installations
- Tamper resistant screw device to protect installations
- Quick Fix Bracket supplied for safe and quick installation

Lamps

- 40, 60, 75, 100W, A/c (IA/c) Edison screw incandescent. Cap: E27
- 9W, TC-S (FSD) compact fluorescent. Cap: G23
- 9W, TC-SEL (FSD) compact fluorescent. Cap: 2G7
- 18W, TC-D (FSD) compact fluorescent. Cap: G24d-2
- 18W, TC-DEL (FSD) compact fluorescent. Cap: G24q-2
- 16, 28W, TC-DD (FSS) compact fluorescent. Cap: GR8
- 16, 28, 38W, TC-DDEL (FSS) compact fluorescent. Cap: GR10q

Materials/Finish

Body: polycarbonate
 Bezel, grille and visor: polycarbonate, white or black finish
 Diffuser: opal polycarbonate or glass

Installation/Mounting

Suitable for surface mounting on wall or ceiling for both interior or exterior use. 'Quick Fix Bracket' (QFB) screw fixed onto mounting surface by 4 oblong holes (4.5mm x 10mm). Main connection via 6 way connecting block. 'Light Box' direct and auto-connected to the QFB. For loop wiring a double 20mm cable entry holes to rear of QFB.

Standards

Designed and manufactured to comply with EN60598, EN55015: 2000 (EMC). Emergency versions with EN60598-2.22.

- Class I Electrical – All electronic versions
- Class II Electrical – Incandescent and magnetic versions

⚡⚡ IP65 ⚡⚡ CE

Specification

To specify state:
 Fresh and contemporary circular luminaire for 40, 60, 75, 100W/A/c Edison screw incandescent, 9W/TC-S, 9W/TC-SEL, 18W/TC-D, 18W/TC-DEL, 16, 28W/TC-DD, 16, 28, 38W/TC-DDEL compact fluorescent lamps with polycarbonate body and opal diffuser in either glass or polycarbonate with standard, grille or visor bezels in colour with lamp, magnetic, electronic, integral emergency gear, connected to Quick Fix Wall and Ceiling Bracket.
 As Thorn Loire.





Dimensions

Photometric data

Ordering guide

Amazon

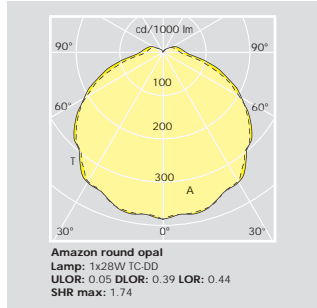

Round, white

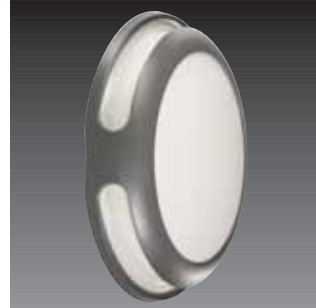

Round, anthracite



Square, silver

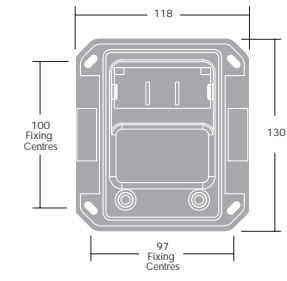
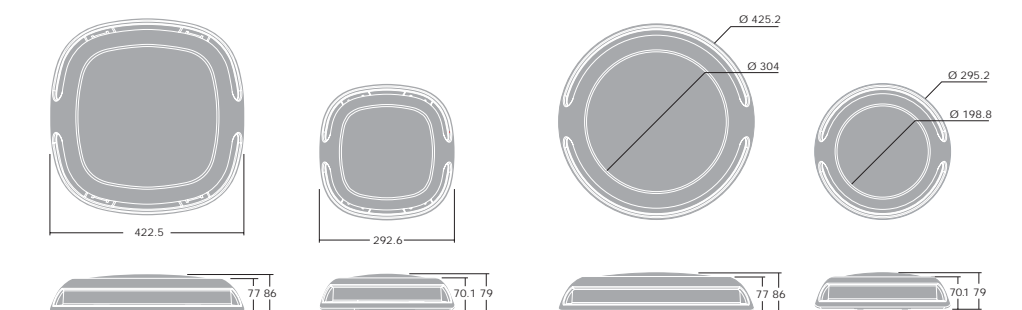
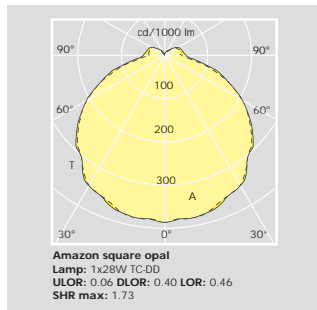

Quick Fix Bracket

Ordering Guide

Supplied complete with Quick Fix Bracket and lamp(s) 4000K

Description	Ilcos Code	Socket	Weight (Kg)	SAP Code		
				White	Silver	Anthracite
Round small						
AM 2X9W TC-SEL HF RD S	FSD	2G7	1.45	96226945	96226946	96226947
AM 1X16W TC-DDEL HF RD S	FSS	GR10q	1.5	96226987	96226988	96226989
Square small						
AM 2X9W TC-SEL HF SQ S	FSD	2G7	1.5	96226948	96226949	96226950
AM 1X16W TC-DDEL HF SQ S	FSS	GR10q	1.55	96226990	96226991	96226992
Round large						
AM 2X18W TC-DEL HF RD L	FSD	G24q-2	2.85	96226951	96226953	96226955
AM 2X18W TC-DEL HFD RD L	FSD	G24q-2	2.85	96226952	96226954	96226956
AM 2X26W TC-DEL HF RD L	FSD	G24q-3	2.9	96226969	96226971	96226973
AM 2X26W TC-DEL HFD RD L	FSD	G24q-3	2.9	96226970	96226972	96226974
AM 1X28W TC-DDEL HF RD L	FSS	GR10q	2.65	96226993	96226994	96226995
AM 1X38W TC-DDEL HF RD L	FSS	GR10q	2.8	96227005	96227006	96227007
AM 1X40W T16-R HF RD L	FSC	2GX13	2.4	96226981	96226983	96226985
AM 1X40W T16-R HFD RD L	FSC	2GX13	2.4	96226982	96226984	96226986
AM 1X55W T16-R HF RD L	FSC	2GX13	2.4	96227017	96227019	96227021
AM 1X55W T16-R HFD RD L	FSC	2GX13	2.4	96227018	96227020	96227022
Round large - emergency versions						
AM 2X18W TC-DEL HF E3 RD L	FSD	G24q-2	3.5	96226963	96226964	96226965
AM 1X28W TC-DDEL HF E3 RD L	FSS	GR10q	3.4	96226999	96227000	96227001
AM 1X38W TC-DDEL HF E3 RD L	FSS	GR10q	3.6	96227011	96227012	96227013
Square large						
AM 2X18W TC-DEL HF SQ L	FSD	G24q-2	3	96226957	96226959	96226961
AM 2X18W TC-DEL HFD SQ L	FSD	G24q-2	3	96226958	96226960	96226962
AM 2X26W TC-DEL HF SQ L	FSD	G24q-3	3.05	96226975	96226977	96226979
AM 2X26W TC-DEL HFD SQ L	FSD	G24q-3	3.05	96226976	96226978	96226980
AM 1X28W TC-DDEL HF SQ L	FSS	GR10q	2.8	96226996	96226997	96226998
AM 1X38W TC-DDEL HF SQ L	FSS	GR10q	2.95	96227008	96227009	96227010
Square large - emergency versions						
AM 2X18W TC-DEL HF SQ L	FSD	G24q-2	3.5	96226966	96226967	96226968
AM 1X28W TC-DDEL HF E3 SQ L	FSS	GR10q	3.6	96227002	96227003	96227004
AM 1X38W TC-DDEL HF E3 SQ L	FSS	GR10q	3.7	96227014	96227015	96227016

HF - High Frequency, HFD - High Frequency Dimmable Digital

Dimensions

Photometric data

Ordering guide

Thames

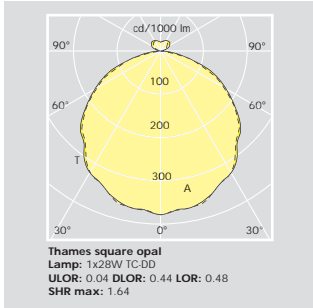

Square, white



Round, satin chrome



Round, white

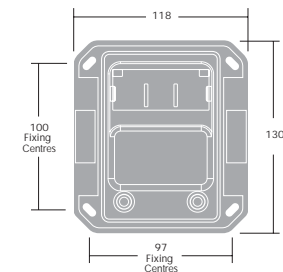
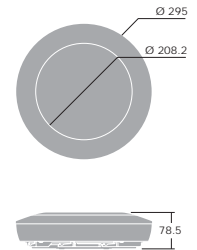
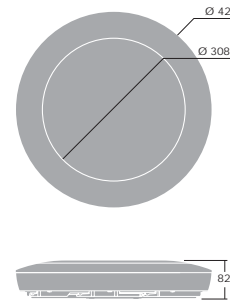
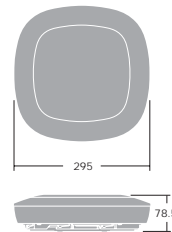
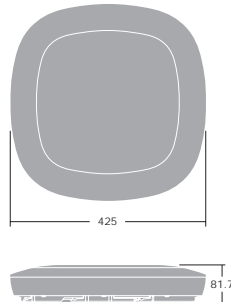
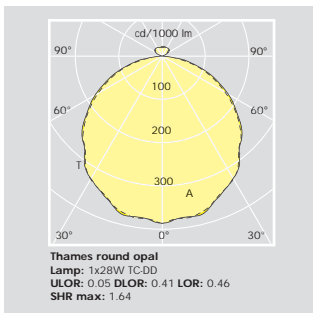

Quick Fix Bracket

Ordering Guide Supplied complete with Quick Fix Bracket and lamp(s) 4000K

Description	Ilcos Code	Socket	Weight (Kg)	SAP Code		Satin Chrome
				White	Silver	
Round small						
TH 2X9W TC-SEL HF RD S	FSD	2G7	1.65	96226831	96226832	96226833
TH 2X9W TC-S NC RD S	FSD	G23	1.95	96226834	96226835	96226836
TH 1X16W TC-DDEL HF RD S	FSS	GR10q	1.70	96226879	96226880	96226881
TH 1X16W TC-DD NC RD S	FSS	GR8	2	96226882	96226883	96226884
Square small						
TH 2X9W TC-SEL HF SQ S	FSD	2G7	1.7	96226837	96226838	96226839
TH 2X9W TC-S NC SQ S	FSD	G23	2	96226840	96226841	96226842
TH 1X16W TC-DDEL HF SQ S	FSS	GR10q	1.75	96226885	96226886	96226887
TH 1X16W TC-DD NC RD S	FSS	GR8	2.05	96226888	96226889	96226890
Round large						
TH 2X18W TC-DEL HF RD L	FSD	G24q-2	3.15	96226843	96226845	96226847
TH 2X18W TC-DEL HFD RD L	FSD	G24q-2	3.15	96226844	96226846	96226848
TH 2X26W TC-DEL HF RD L	FSD	G24q-3	3.2	96226861	96226863	96226865
TH 2X26W TC-DEL HFD RD L	FSD	G24q-3	3.2	96226862	96226864	96226866
TH 1X28W TC-DDEL HF RD L	FSS	GR10q	2.9	96226891	96226892	96226893
TH 1X38W TC-DDEL HF RD L	FSS	GR10q	3.05	96226903	96226904	96226905
TH 1X40W T16-R HF RD L	FSC	2GX13	2.7	96226873	96226875	96226877
TH 1X40W T16-R HFD RD L	FSC	2GX13	2.7	96226874	96226876	96226878
TH 1X55W T16-R HF RD L	FSC	2GX13	2.7	96228869	96228871	96228873
TH 1X55W T16-R HFD RD L	FSC	2GX13	2.7	96228870	96228872	96228874
Round large - emergency versions						
TH 2X18W TC-DEL HF E3 RD L	FSD	G24q-2	3.7	96226855	96226856	96226857
TH 1X28W TC-DDEL HF E3 RD L	FSS	GR10q	3.7	96226897	96226898	96226899
TH 1X38W TC-DDEL HF E3 RD L	FSS	GR10q	3.7	96226909	96226910	96226911
Square large						
TH 2X18W TC-DEL HF SQ L	FSD	G24q-2	3.35	96226849	96226851	96226853
TH 2X18W TC-DEL HFD SQ L	FSD	G24q-2	3.35	96226850	96226852	96226854
TH 2X26W TC-DEL HF SQ L	FSD	G24q-3	3.4	96226867	96226869	96226871
TH 2X26W TC-DEL HFD SQ L	FSD	G24q-3	3.4	96226868	96226870	96226872
TH 1X28W TC-DDEL HF SQ L	FSS	GR10q	3.1	96226894	96226895	96226896
TH 1X38W TC-DDEL HF SQ L	FSS	GR10q	3.3	96226906	96226907	96226908
Square large - emergency versions						
TH 2X18W TC-DEL HF E3 SQ L	FSD	G24q-2	4.0	96226858	96226859	96226860
TH 1X28W TC-DDEL HF E3 SQ L	FSS	GR10q	4.0	96226900	96226901	96226902
TH 1X38W TC-DDEL HF E3 SQ L	FSS	GR10q	4.0	96226912	96226913	96226914

HF - High Frequency, NC - Magnetic (not compensated), HFD - High Frequency Dimmable Digital

Seine

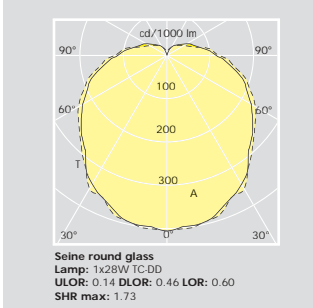

Large, round



Large, square

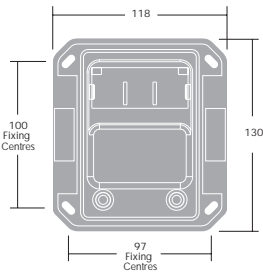
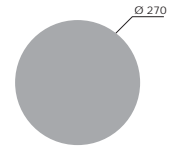
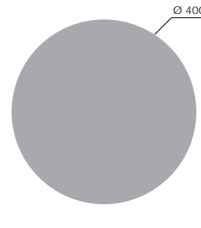
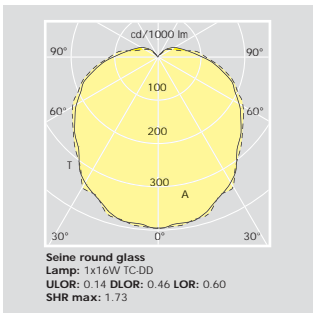

Quick Fix Bracket

Ordering Guide Supplied complete with Quick Fix Bracket and lamp(s) 4000K

Description	Ilcos Code	Socket	Weight (Kg)	SAP Code
Round small				
SE 1X40W A CL2 E27 RD S	IA/C	E27	2.9	96226915
SE 1X60W A CL2 E27 RD S	IA/C	E27	2.9	96226917
SE 2X9W TC-SEL HF RD S	FSD	2G7	2.7	96226919
SE 1X16W TC-DDEL HF RD S	FSS	GR10q	2.9	96226935
Square small				
SE 1X40W A CL2 E27 SQ S	IA/C	E27	2.9	96226916
SE 1X60W A CL2 E27 SQ S	IA/C	E27	2.9	96226918
SE 2X9W TC-SEL HF SQ S	FSD	2G7	2.7	96226920
SE 1X16W TC-DDEL HF SQ S	FSS	GR10q	2.9	96226936
Round large				
SE 2X18W TC-DEL HF RD L	FSD	G24q-2	4.6	96226921
SE 2X18W TC-DEL HFD RD L	FSD	G24q-2	4.6	96226922
SE 2X26W TC-DEL HF RD L	FSQ	G24q-3	4.85	96226927
SE 2X26W TC-DEL HFD RD L	FSQ	G24q-3	4.85	96226928
SE 1X28W TC-DDEL HF RD L	FSS	GR10q	4.6	96226937
SE 1X38W TC-DDEL HF RD L	FSS	GR10q	4.75	96226941
SE 1X40W T16-R HF RD L	FSC	2GX13	4.5	96226931
SE 1X40W T16-R HFD RD L	FSC	2GX13	4.5	96226932
SE 1X55W T16-R HF RD L	FSC	2GX13	4.5	96226933
SE 1X55W T16-R HFD RD L	FSC	2GX13	4.5	96226934
Round large - emergency versions				
SE 2X18W TC-DEL HF E3 RD L	FSD	G24q-2	5.4	96226925
SE 1X28W TC-DDEL HF E3 RD L	FSS	GR10q	5.4	96226939
SE 1X38W TC-DDEL HF E3 RD L	FSS	GR10q	5.4	96226943
Square large				
SE 2X18W TC-DEL HF SQ L	FSD	G24q-2	5.05	96226923
SE 2X18W TC-DEL HFD SQ L	FSD	G24q-2	5.05	96226924
SE 2X26W TC-DEL HF SQ L	FSQ	G24q-3	5.05	96226929
SE 2X26W TC-DEL HFD SQ L	FSQ	G24q-3	5.05	96226930
SE 1X28W TC-DDEL HF SQ L	FSS	GR10q	4.8	96226938
SE 1X38W TC-DDEL HF SQ L	FSS	GR10q	4.95	96226942
Square large - emergency versions				
SE 2X18W TC-DEL HF E3 SQ L	FSD	G24q-2	5.6	96226926
SE 1X28W TC-DDEL HF E3 SQ L	FSS	GR10q	5.6	96226940
SE 1X38W TC-DDEL HF E3 SQ L	FSS	GR10q	5.6	96226944

HF - High Frequency, HFD - High Frequency Dimmable Digital, CL2 - Class II Electrical

Dimensions

Photometric data

Ordering guide

Danube



Round, white



Round with visor, black



Round prismatic, black

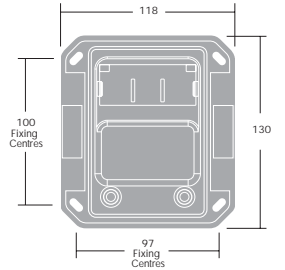

Quick Fix Bracket

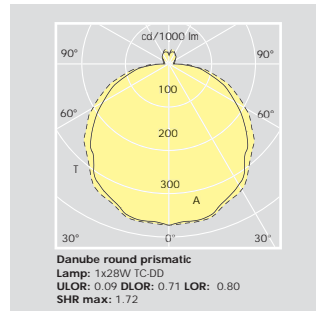
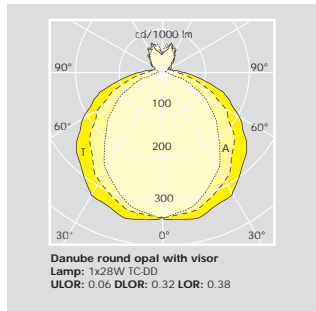
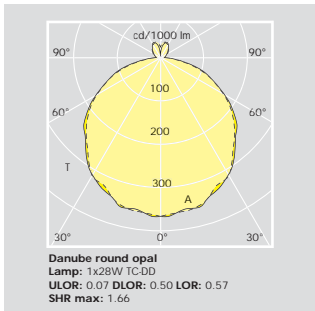

Ordering Guide Supplied complete with Quick Fix Bracket and lamp(s) 4000K

Description	Icos Code	Socket	Wt (Kg)	SAP Code Black	White
Opal diffuser - round small					
DA 2X9W TC-SEL HF CL1 OP RD S	FSD	2G7	0.9	96218903	96218904
DA 2X9W TC-S NC CL2 OP RD S	FSD	G23	1.2	96218905	96218906
DA 1X16W TC-DDEL HF CL1 OP RD S	FSS	GR10q	0.95	96219039	96219040
DA 1X16W TC-DD NC CL2 OP RD S	FSS	GR8	1.2	96219041	96219042
Opal diffuser with visor - round small					
DA VIS 2X9W TC-SEL HF CL1 OP RD S	FSD	2G7	1	96218911	96218912
DA VIS 2X9W TC-S NC CL2 OP RD S	FSD	G23	1.3	96218913	96218914
DA VIS 1X16W TC-DDEL HF CL1 OP RD S	FSS	GR10q	1.05	96219047	96219048
DA VIS 1X16W TC-DD NC CL2 OP RD S	FSS	GR8	1.3	96219049	96219050
Opal diffuser with grille - round small					
DA GRIL 2X9W TC-SEL HF CL1 OP RD S	FSD	2G7	1	96218919	96218920
DA GRIL 2X9W TC-S NC CL2 OP RD S	FSD	G23	1.3	96218921	96218922
DA GRIL 1X16W TC-DDEL HF CL1 OP RD S	FSS	GR10q	1.05	96219055	96219056
DA GRIL 1X16W TC-DD NC CL2 OP RD S	FSS	GR8	1.3	96219057	96219058
Prismatic diffuser - round small					
DA 2X9W TC-SEL HF CL1 PR RD S	FSD	2G7	0.9	96218927	96218928
DA 2X9W TC-S NC CL2 PR RD S	FSD	G23	1.2	96218929	96218930
DA 1X16W TC-DDEL HF CL1 PR RD S	FSS	GR10q	0.95	96219063	96219064
DA 1X16W TC-DD NC CL2 PR RD S	FSS	GR8	1.2	96219065	96219066
Opal diffuser - square small					
DA 2X9W TC-SEL HF CL1 OP SQ S	FSD	2G7	0.9	96218907	96218908
DA 2X9W TC-S NC CL2 OP SQ S	FSD	G23	1.2	96218909	96218910
DA 1X16W TC-DDEL HF CL1 OP SQ S	FSS	GR10q	0.95	96219043	96219044
DA 1X16W TC-DD NC CL2 OP SQ S	FSS	GR8	1.2	96219045	96219046
Opal diffuser with visor - square small					
DA VIS 2X9W TC-SEL HF CL1 OP SQ S	FSD	2G7	1	96218915	96218916
DA VIS 2X9W TC-S NC CL2 OP SQ S	FSD	G23	1.3	96218917	96218918
DA VIS 1X16W TC-DDEL HF CL1 OP SQ S	FSS	GR10q	1.05	96219051	96219052
DA VIS 1X16W TC-DD NC CL2 OP SQ S	FSS	GR8	1.3	96219053	96219054
Opal diffuser with grille - square small					
DA GRIL 2X9W TC-SEL HF CL1 OP SQ S	FSD	2G7	1	96218923	96218924
DA GRIL 2X9W TC-S NC CL2 OP SQ S	FSD	G23	1.3	96218925	96218926
DA GRIL 1X16W TC-DDEL HF CL1 OP SQ S	FSS	GR10q	1.05	96219059	96219060
DA GRIL 1X16W TC-DD NC CL2 OP SQ S	FSS	GR8	1.3	96219061	96219062

Description	Icos Code	Socket	Wt (Kg)	SAP Code Black	White
Prismatic diffuser- square small					
DA 2X9W TC-SEL HF CL1 PR SQ S	FSD	2G7	0.9	96218931	96218932
DA 2X9W TC-S NC CL2 PR SQ S	FSD	G23	1.2	96218933	96218934
DA 1X16W TC-DDEL HF CL1 PR SQ S	FSS	GR10q	0.95	96219067	96219068
DA 1X16W TC-DD NC CL2 PR SQ S	FSS	GR8	1.2	96219069	96219070
Opal diffuser - round large					
DA 2X18W TC-DEL HF CL1 OP RD L	FSD	G24q-2	2.1	96218935	96218936
DA 2X18W TC-DEL HFD CL1 OP RD L	FSD	G24q-2	2.1	96218943	96218944
DA 2X18W TC-D CP CL2 OP RD L	FSD	G24d-2	2.5	96218937	96218938
DA 2X26W TC-DEL HFD CL1 OP RD L	FSD	G24q-3	1.9	96219015	96219015
DA 2X26W TC-DEL HF CL1 OP RD L	FSD	G24q-3	1.9	96218983	96218984
DA 2X26W TC-D CP CL2 OP RD L	FSD	G24d-3	2.5	96218985	96218986
DA 1X28W TC-DDEL HF CL1 OP RD L	FSS	GR10q	1.65	96219071	96219072
DA 1X28W TC-DD CP CL2 OP RD L	FSS	GR8	2.05	96219073	96219074
DA 1X38W TC-DDEL HF CL1 OP RD L	FSS	GR10q	1.8	96219119	96219120
DA 1X40W T16-R HF CL1 OP RD L	FSC	2GX13	1.65	96219031	96219032
Opal diffuser - round large - emergency versions					
DA 1X28W TC-DDEL HF CL1 E3 OP RD L	FSS	GR10q	2.5	96219103	96219104
DA 1X38W TC-DDEL HF CL1 E3 OP RD L	FSS	GR10q	2.5	96219135	96219136
Opal diffuser with visor - round large					
DA VIS 2X18W TC-DEL HFD CL1 OP RD L	FSD	G24q-2	2.25	96218947	96218948
DA VIS 2X18W TC-DEL HF CL1 OP RD L	FSD	G24q-2	2.25	96218959	96218960
DA VIS 2X18W TC-D CP CL2 OP RD L	FSD	G24d-2	2.65	96218961	96218962
DA VIS 2X26W TC-DEL HFD CL1 OP RD L	FSD	G24q-3	2.05	96219019	96219020
DA VIS 2X26W TC-DEL HF CL1 OP RD L	FSD	G24q-3	2.05	96218991	96218992
DA VIS 2X26W TC-D CP CL2 OP RD L	FSD	G24d-3	2.65	96218993	96218994
DA VIS 1X28W TC-DDEL HF CL1 OP RD L	FSS	GR10q	1.8	96219079	96219080
DA VIS 1X28W TC-DD CP CL2 OP RD L	FSS	GR8	2.2	96219081	96219082
DA VIS 1X38W TC-DDEL HF CL1 OP RD L	FSS	GR10q	1.95	96219123	96219124
DA VIS 1X40W T16-R HF CL1 OP RD L	FSC	2GX13	1.8	96219033	96219034
Opal diffuser with visor - round large - emergency versions					
DA VIS 1X28W TC-DDEL HF CL1 E3 OP RD L	FSS	GR10q	2.65	96219107	96219108
DA VIS 1X38W TC-DDEL HF CL1 E3 OP RD L	FSS	GR10q	2.65	96219139	96219140

Danube

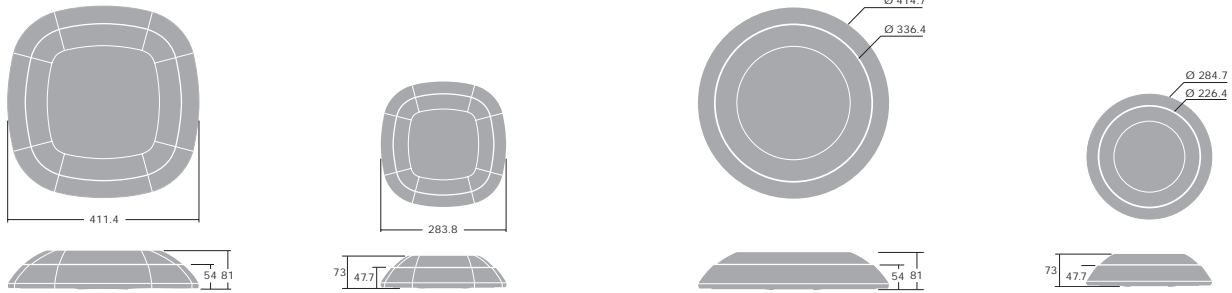

Ordering Guide Supplied complete with Quick Fix Bracket and lamp(s) 4000K

Description	Ilcos Code	Socket	Wt (Kg)	SAP Code Black	White
Opal diffuser with grille - round large					
DA GRIL 2X18W TC-DEL HFD CL1 OP RD L	FSD	G24q-2	2.25	96218951	96218952
DA GRIL 2X18W TC-DEL HF CL1 OP RD L	FSD	G24q-2	2.25	96218967	96218968
DA GRIL 2X18W TC-D CP CL2 OP RD L	FSD	G24d-2	2.65	96218969	96218970
DA GRIL 2X26W TC-DEL HF CL1 OP RD L	FSQ	G24q-3	2.05	96218999	96219000
DA GRIL 2X26W TC-DEL HFD CL1 OP RD L	FSQ	G24q-3	2.05	96219023	96219024
DA GRIL 2X26W TC-D CP CL2 OP RD L	FSQ	G24d-3	2.65	96219001	96219002
DA GRIL 1X28W TC-DDEL HF CL1 OP RD L	FSS	GR10q	1.8	96219087	96219088
DA GRIL 1X28W TC-DD CP CL2 OP RD L	FSS	GR8	2.2	96219089	96219090
DA GRIL 1X38W TC-DDEL HF CL1 OP RD L	FSS	GR10q	1.95	96219127	96219128
DA GRIL 1X40W T16-R HF CL1 OP RD L	FSC	2GX13	1.8	96219035	96219036

Opal diffuser with grille - round large - emergency versions					
DA GRIL 1X28W TC-DDEL HF CL1 E3 OP RD L	FSS	GR10q	2.65	96219111	96219112
DA GRIL 1X38W TC-DDEL HF CL1 E3 OP RD L	FSS	GR10q	2.65	96219143	96219144

Prismatic diffuser - round large					
DA 2X18W TC-DEL HFD CL1 PR RD L	FSD	G24q-2	2.1	96218955	96218956
DA 2X18W TC-DEL HF CL1 PR RD L	FSD	G24q-2	2.1	96218975	96218976
DA 2X18W TC-D CP CL2 PR RD L	FSD	G24d-2	2.5	96218977	96218978
DA 2X26W TC-DEL HF CL1 PR RD L	FSQ	G24q-3	1.9	96219007	96219008
DA 2X26W TC-D CP CL2 PR RD L	FSQ	G24q-3	2.5	96219009	96219010
DA 2X26W TC-DEL HFD CL1 PR RD L	FSQ	G24d-3	2.05	96219027	96219028
DA 1X28W TC-DDEL HF CL1 PR RD L	FSS	GR10q	1.65	96219095	96219096
DA 1X28W TC-DD CP CL2 PR RD L	FSS	GR8	2.05	96219097	96219098
DA 1X38W TC-DDEL HF CL1 PR RD L	FSS	GR10q	1.8	96219131	96219132
DA 1X40W T16-R HF CL1 PR RD L	FSC	2GX13	1.65	96219037	96219038

Prismatic diffuser - round large - emergency versions					
DA 1X28W TC-DDEL HF CL1 E3 PR RD L	FSS	GR10q	2.5	96219115	96219116
DA 1X38W TC-DDEL HF CL1 E3 PR RD L	FSS	GR10q	2.5	96219147	96219148

Opal diffuser - square large					
DA 2X18W TC-DEL HF CL1 OP SQ L	FSD	G24q-2	1.95	96218939	96218940
DA 2X18W TC-DEL HFD CL1 OP SQ L	FSD	G24q-2	1.95	96218945	96218946
DA 2X18W TC-D CP CL2 OP SQ L	FSD	G24d-2	2.5	96218941	96218942
DA 2X26W TC-DEL HF CL1 OP SQ L	FSQ	G24q-3	1.95	96218987	96218988
DA 2X26W TC-DEL HFD CL1 OP SQ L	FSQ	G24q-3	1.95	96219017	96219018
DA 2X26W TC-D CP CL2 OP SQ L	FSQ	G24d-3	2.5	96218989	96218990
DA 1X28W TC-DDEL HF CL1 OP SQ L	FSS	GR10q	1.7	96219075	96219076
DA 1X28W TC-DD CP CL2 OP SQ L	FSS	GR8	2.1	96219077	96219078
DA 1X38W TC-DDEL HF CL1 OP SQ L	FSS	GR10q	1.85	96219121	96219122

Opal diffuser - square large - emergency versions					
DA 1X28W TC-DDEL HF CL1 E3 OP SQ L	FSS	GR10q	2.5	96219105	96219106
DA 1X38W TC-DDEL HF CL1 E3 OP SQ L	FSS	GR10q	2.5	96219137	96219138

Opal diffuser with visor - square large					
DA VIS 2X18W TC-DEL HFD CL1 OP SQ L	FSD	G24q-2	2.1	96218949	96218950
DA VIS 2X18W TC-DEL HF CL1 OP SQ L	FSD	G24q-2	2.1	96218963	96218964
DA VIS 2X18W TC-D CP CL2 OP SQ L	FSD	G24d-2	2.65	96218965	96218966
DA VIS 2X26W TC-DEL HF CL1 OP SQ L	FSQ	G24q-3	2.1	96218995	96218996
DA VIS 2X26W TC-DEL HFD CL1 OP SQ L	FSQ	G24q-3	2.1	96219021	96219022
DA VIS 2X26W TC-D CP CL2 OP SQ L	FSQ	G24d-3	2.65	96218997	96218998
DA VIS 1X28W TC-DDEL HF CL1 OP SQ L	FSS	GR10q	1.85	96219083	96219084
DA VIS 1X28W TC-DD CP CL2 OP SQ L	FSS	GR8	2.25	96219085	96219086
DA VIS 1X38W TC-DDEL HF CL1 OP SQ L	FSS	GR10q	2	96219125	96219126

Description	Ilcos Code	Socket	Wt (Kg)	SAP Code Black	White
Opal diffuser with visor - square large - emergency versions					
DA VIS 1X28W TC-DDEL HF CL1 E3 OP SQ L	FSS	GR10q	2.65	96219109	96219110
DA VIS 1X38W TC-DDEL HF CL1 E3 OP SQ L	FSS	GR10q	2.65	96219141	96219142

Opal diffuser with grille - square large					
DA GRIL 2X18W TC-DEL HFD CL1 OP SQ L	FSD	G24q-2	2.1	96218953	96218954
DA GRIL 2X18W TC-DEL HF CL1 OP SQ L	FSD	G24q-2	2.1	96218971	96218972
DA GRIL 2X18W TC-D CP CL2 OP SQ L	FSD	G24d-2	2.65	96218973	96218974
DA GRIL 2X26W TC-DEL HF CL1 OP SQ L	FSQ	G24q-3	2.1	96219003	96219004
DA GRIL 2X26W TC-DEL HFD CL1 OP SQ L	FSQ	G24q-3	2.1	96219025	96219026
DA GRIL 2X26W TC-D CP CL2 OP SQ L	FSQ	G24d-3	2.65	96219005	96219006
DA GRIL 1X28W TC-DDEL HF CL1 OP SQ L	FSS	GR10q	1.85	96219091	96219092
DA GRIL 1X28W TC-DD CP CL2 OP SQ L	FSS	GR8	2.25	96219093	96219094
DA GRIL 1X38W TC-DDEL HF CL1 OP SQ L	FSS	GR10q	2	96219129	96219130

Opal diffuser with grille - square large - emergency versions					
DA GRIL 1X28W TC-DDEL HF CL1 E3 OP SQ L	FSS	GR10q	2.65	96219113	96219114
DA GRIL 1X38W TC-DDEL HF CL1 E3 OP SQ L	FSS	GR10q	2.65	96219145	96219146

Prismatic diffuser - square large					
DA 2X18W TC-DEL HFD CL1 PR SQ L	FSD	G24q-2	1.95	96218957	96218958
DA 2X18W TC-DEL HF CL1 PR SQ L	FSD	G24q-2	1.95	96218979	96218980
DA 2X18W TC-D CP CL2 PR SQ L	FSD	G24d-2	2.5	96218981	96218982
DA 2X26W TC-DEL HF CL1 PR SQ L	FSQ	G24q-3	1.95	96219011	96219012
DA 2X26W TC-DEL HFD CL1 PR SQ L	FSQ	G24q-3	2.1	96219029	96219030
DA 2X26W TC-D CP CL2 PR SQ L	FSQ	G24d-3	2.5	96219013	96219014
DA 1X28W TC-DDEL HF CL1 PR SQ L	FSS	GR10q	1.7	96219099	96219100
DA 1X28W TC-DD CP CL2 PR SQ L	FSS	GR8	2.1	96219101	96219102
DA 1X38W TC-DDEL HF CL1 PR SQ L	FSS	GR10q	1.85	96219133	96219134

Prismatic diffuser - square large - emergency versions					
DA 1X28W TC-DDEL HF CL1 E3 PR SQ L	FSS	GR10q	2.5	96219117	96219118
DA 1X38W TC-DDEL HF CL1 E3 PR SQ L	FSS	GR10q	2.5	96219149	96219150

HF - High Frequency, HFD - High Frequency Dimmable Digital,
 NC - Magnetic (not compensated), CP - Magnetic (parallel compensated),
 CL1 - Class I Electrical, CL2 - Class II Electrical

Dimensions

Photometric data

Ordering guide

Loire



Round, white

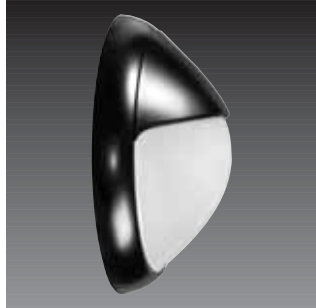

Round with visor, black

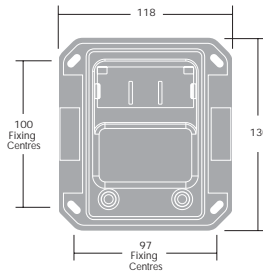
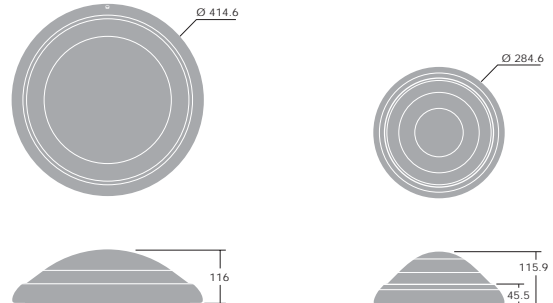
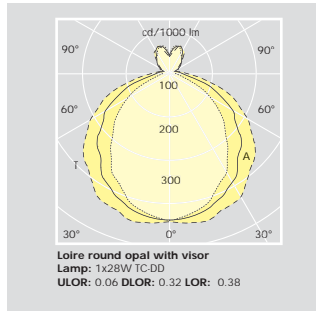
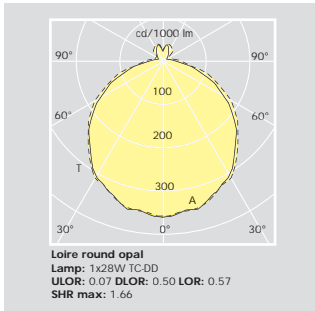

Quick Fix Bracket

Ordering Guide Supplied complete with Quick Fix Bracket and lamp(s) 4000K

Description	Icos Code	Socket	Wt (Kg)	SAP Code	
				Black	White
Polycarbonate diffuser- small					
LO 1X40W A CL2 PC S IP65	IA/C	E27	0.75	96219151	96219152
LO 1X60W A CL2 PC S IP65	IA/C	E27	0.75	96219153	96219154
LO 1X75W A CL2 PC S IP65	IA/C	E27	0.75	96219155	96219156
LO 2X9W TC-SEL HF CL1 PC S IP65	FSD	2G7	0.9	96219159	96219160
LO 2X9W TC-S NC CL2 PC S IP65	FSD	G23	1.2	96219161	96219162
LO 1X16W TC-DDEL HF CL1 PC S IP65	FSS	GR10q	0.95	96219167	96219168
LO 1X16W TC-DD NC CL2 PC S IP65	FSS	GR8	1.2	96219169	96219170
Polycarbonate diffuser with visor - small					
LO VIS 1X40W A CL2 PC S IP65	IA/C	E27	0.9	96226711	96226712
LO VIS 1X60W A CL2 PC S IP65	IA/C	E27	0.9	96226713	96226714
LO VIS 1X75W A CL2 PC S IP65	IA/C	E27	0.9	96226715	96226716
LO VIS 2X9W TC-SEL HF CL1 PC S IP65	FSD	2G7	1	96226719	96226720
LO VIS 2X9W TC-S NC CL2 PC S IP65	FSD	G23	1.3	96226721	96226722
LO VIS 1X16W TC-DDEL HF CL1 PC S IP65	FSS	GR10q	1.05	96226727	96226728
LO VIS 1X16W TC-DD NC CL2 PC S IP65	FSS	GR8	1.3	96226729	96226730
Polycarbonate diffuser with grille - small					
LO GRIL 1X40W A CL2 PC S IP65	IA/C	E27	0.9	96226771	96226772
LO GRIL 1X60W A CL2 PC S IP65	IA/C	E27	0.9	96226773	96226774
LO GRIL 1X75W A CL2 PC S IP65	IA/C	E27	0.9	96226775	96226776
LO GRIL 2X9W TC-SEL HF CL1 PC S IP65	FSD	2G7	1	96226779	96226780
LO GRIL 2X9W TC-S NC CL2 PC S IP65	FSD	G23	1.3	96226781	96226782
LO GRIL 1X16W TC-DDEL HF CL1 PC S IP65	FSS	GR10q	1.05	96226787	96226788
LO GRIL 1X16W TC-DD NC CL2 PC S IP65	FSS	GR8	1.3	96226789	96226790
Glass diffuser - small					
LO 1X40W A CL2 GL S IP20	IA/C	E27	1.5	96219181	96219182
LO 1X60W A CL2 GL S IP20	IA/C	E27	1.5	96219183	96219184
LO 1X75W A CL2 GL S IP20	IA/C	E27	1.5	96219185	96219186
LO 2X9W TC-SEL HF CL1 GL S IP20	FSD	2G7	1.6	96219189	96219190
LO 2X9W TC-S NC CL2 GL S IP20	FSD	G23	1.95	96219191	96219192
LO 1X16W TC-DDEL HF CL1 GL S IP20	FSS	GR10q	1.7	96219197	96219198
LO 1X16W TC-DD NC CL2 GL S IP20	FSS	GR8	1.95	96219199	96226700
Glass diffuser with visor - small					
LO VIS 1X40W A CL2 GL S IP20	IA/C	E27	1.9	96226741	96226742
LO VIS 1X60W A CL2 GL S IP20	IA/C	E27	1.9	96226743	96226744
LO VIS 1X75W A CL2 GL S IP20	IA/C	E27	1.9	96226745	96226746
LO VIS 2X9W TC-SEL HF CL1 GL S IP20	FSD	2G7	2	96226749	96226750

Description	Icos Code	Socket	Wt (Kg)	SAP Code	
				Black	White
LO VIS 2X9W TC-S NC CL2 GL S IP20	FSD	G23	2.3	96226751	96226752
LO VIS 1X16W TC-DDEL HF CL1 GL S IP20	FSS	GR10q	2.05	96226757	96226758
LO VIS 1X16W TC-DD NC CL2 GL S IP20	FSS	GR8	2.3	96226759	96226760
Glass diffuser with grille - small					
LO GRIL 1X40W A CL2 GL S IP20	IA/C	E27	1.9	96226801	96226802
LO GRIL 1X60W A CL2 GL S IP20	IA/C	E27	1.9	96226803	96226804
LO GRIL 1X75W A CL2 GL S IP20	IA/C	E27	1.9	96226805	96226806
LO GRIL 2X9W TC-SEL HF CL1 GL S IP20	FSD	2G7	2	96226809	96226810
LO GRIL 2X9W TC-S NC CL2 GL S IP20	FSD	G23	2.3	96226811	96226812
LO GRIL 1X16W TC-DDEL HF CL1 GL S IP20	FSS	GR10q	2.05	96226817	96226818
LO GRIL 1X16W TC-DD NC CL2 GL S IP20	FSS	GR8	2.3	96226819	96226820
Polycarbonate diffuser - large					
LO 1X100W A CL2 PC L IP65	IA/C	E27	1.4	96219157	96219158
LO 2X18W TC-DEL HF CL1 PC L IP65	FSD	G24q2	2.1	96219163	96219164
LO 2X18W TC-D CP CL2 PC L IP65	FSD	G24d2	2.5	96219165	96219166
LO 1X28W TC-DDEL HF CL1 PC L IP65	FSS	GR10q	1.6	96219171	96219172
LO 1X28W TC-DD CP CL2 PC L IP65	FSS	GR8	2.05	96219173	96219174
LO 1X38W TC-DDEL HF CL1 PC L IP65	FSS	GR10q	1.8	96219177	96219178
Polycarbonate diffuser - large - emergency					
LO 1X28W TC-DDEL HF CL1 E3 PC L IP65	FSS	GR10q	2.5	96219175	96219176
LO 1X38W TC-DDEL HF CL1 E3 PC L IP65	FSS	GR10q	2.5	96219179	96219180
Polycarbonate diffuser with visor - large					
LO VIS 1X100W A CL2 PC L IP65	IA/C	E27	1.6	96226717	96226718
LO VIS 2X18W TC-DEL HF CL1 PC L IP65	FSD	G24q2	2.25	96226723	96226724
LO VIS 2X18W TC-D CP CL2 PC L IP65	FSD	G24d2	2.65	96226725	96226726
LO VIS 1X28W TC-DDEL HF CL1 PC L IP65	FSS	GR10q	2.6	96226731	96226732
LO VIS 1X28W TC-DD CP CL2 PC L IP65	FSS	GR8	2.2	96226733	96226734
LO VIS 1X38W TC-DDEL HF CL1 PC L IP65	FSS	GR10q	1.95	96226737	96226738
Polycarbonate diffuser with visor - large - emergency versions					
LO VIS 1X28W TC-DDEL HF CL1 E3 PC L IP65	FSS	GR10q	2.65	96226735	96226736
LO VIS 1X38W TC-DDEL HF CL1 E3 PC L IP65	FSS	GR10q	2.65	96226739	96226740

Loire

Description	Iicos Code	Socket	Wt (Kg)	SAP Code Black	White
Polycarbonate diffuser with grille - large					
LO GRIL 1X100W A CL2 PC L IP65	IA/C	E27	1.6	96226777	96226778
LO GRIL 2X18W TC-DEL HF CL1 PC L IP65	FSD	G24q-2	2.25	96226783	96226784
LO GRIL 2X18W TC-D CP CL2 PC L IP65	FSD	G24d-2	2.65	96226785	96226786
LO GRIL 1X28W TC-DDEL HF CL1 PC L IP65	FSS	GR10q	2.6	96226791	96226792
LO GRIL 1X28W TC-DD CP CL2 PC L IP65	FSS	GR8	2.2	96226793	96226794
LO GRIL 1X38W TC-DDEL HF CL1 PC L IP65	FSS	GR10q	1.95	96226797	96226798
Polycarbonate diffuser with grille - large - emergency versions					
LO GRIL 1X28W TC-DDEL HF CL1 E3 PC L IP65	FSS	GR10q	2.65	96226795	96226796
LO GRIL 1X38W TC-DDEL HF CL1 E3 PC L IP65	FSS	GR10q	2.65	96226799	96226800
Glass diffuser - large					
LO 1X100W A CL2 GL L IP20	IA/C	E27	2.65	96219187	96219188
LO 2X18W TC-DEL HF CL1 GL L IP20	FSD	G24q-2	3.35	96219193	96219194
LO 2X18W TC-D CP CL2 GL L IP20	FSD	G24d-2	3.5	96219195	96219196
LO 1X28W TC-DDEL HF CL1 GL L IP20	FSS	GR10q	2.85	96226701	96226702
LO 1X28W TC-DD CP CL2 GL L IP20	FSS	GR8	3.3	96226703	96226704
LO 1X38W TC-DDEL HF CL1 GL L IP20	FSS	GR10q	3.05	96226707	96226708
Glass diffuser - large - emergency versions					
LO 1X28W TC-DDEL HF CL1 E3 GL L IP20	FSS	GR10q	3.75	96226705	96226706
LO 1X38W TC-DDEL HF CL1 E3 GL L IP20	FSS	GR10q	3.75	96226709	96226710
Glass diffuser with visor - large					
LO VIS 1X100W A CL2 GL L IP20	IA/C	E27	2.9	96226747	96226748
LO VIS 2X18W TC-DEL HF CL1 GL L IP20	FSD	G24q-2	3.6	96226753	96226754
LO VIS 2X18W TC-D CP CL2 GL L IP20	FSD	G24d-2	4	96226755	96226756
LO VIS 1X28W TC-DDEL HF CL1 GL L IP20	FSS	GR10q	3.1	96226761	96226762
LO VIS 1X28W TC-DD CP CL2 GL L IP20	FSS	GR8	3.55	96226763	96226764
LO VIS 1X38W TC-DDEL HF CL1 GL L IP20	FSS	GR10q	3.3	96226767	96226768
Glass diffuser with visor - large - emergency versions					
LO VIS 1X28W TC-DDEL HF CL1 E3 GL L IP20	FSS	GR10q	4	96226765	96226766
LO VIS 1X38W TC-DDEL HF CL1 E3 GL L IP20	FSS	GR10q	4	96226769	96226770
Glass diffuser with grille - large					
LO GRIL 1X100W A CL2 GL L IP20	IA/C	E27	2.9	96226807	96226808
LO GRIL 2X18W TC-DEL HF CL1 GL L IP20	FSD	G24q-2	3.6	96226813	96226814
LO GRIL 2X18W TC-D CP CL2 GL L IP20	FSD	G24d-2	4	96226815	96226816
LO GRIL 1X28W TC-DDEL HF CL1 GL L IP20	FSS	GR10q	3.1	96226821	96226822
LO GRIL 1X28W TC-DD CP CL2 GL L IP20	FSS	GR8	3.55	96226823	96226824
LO GRIL 1X38W TC-DDEL HF CL1 GL L IP20	FSS	GR10q	3.3	96226827	96226828
Glass diffuser with grille - large - emergency versions					
LO GRIL 1X28W TC-DDEL HF CL1 E3 GL L IP20	FSS	GR10q	4	96226825	96226826
LO GRIL 1X38W TC-DDEL HF CL1 E3 GL L IP20	FSS	GR10q	4	96226829	96226830

HF - High Frequency, NC - Magnetic (not compensated),
 CP - Magnetic (parallel compensated), CL1 - Class I Electrical, CL2 - Class II Electrical

For Large projects the Quick Fix Bracket can be ordered as an individual item

Accessory	
BULKHEAD ACCESS KIT FIX IP65	96227023

THORN

Lighting people and places

Thorn Lighting Main Offices

Head Office

Thorn Lighting Holdings Limited,
Silver Screens, Elstree Way, Borehamwood,
Hertfordshire, WD6 1FE, UK
Tel: (44) 20 8732 9800
Fax: (44) 20 8732 9801
E-mail: info@thornlight.com
Website: www.thornlighting.com

Australia

Thorn Lighting Pty Limited, 13 Cooper Street,
P O Box 188, Smithfield, NSW 2164, Australia
Tel: (61) 2 9604 4300
Fax: (61) 2 9604 4588
E-mail: info@thornlight.com.au
Website: www.thornlight.com.au

Thorn DNT Airfield Lighting Pty Limited, P O Box 548,
Unit 2, 7-9 Newcastle Road, Bayswater, Melbourne,
Victoria 3153, Australia
Tel: (61) 3 9720 3233
Fax: (61) 3 9720 8233
E-mail: enquiries@thornlight.com.au
Website: www.thornairfield.com

Austria

Thorn Licht GesmbH, Erzherzog Karl-Straße 57,
Wien A-1220, Austria
Tel: (43) 1 202 66 11
Fax: (43) 1 202 66 11 12
E-mail: office@thorn.at

China

Thorn Lighting (Guangzhou) Limited,
(Factory & Guangzhou Office), No 1 Yi Heng Road,
Eastern Section, GETDD, Guangzhou 510760, China
Tel: (86) 20 8224 1706
Fax: (86) 20 8224 5777
E-mail: gzhthorn@public.guangzhou.gd.cn

Thorn Lighting (Tianjin) Company Ltd, 332 Hongqi Road,
Tianjin 300190, China
Tel: (86) 22 8369 2303
Fax: (86) 22 8369 2302
E-mail: thorn@public.tpt.lj.cn

Thorn Lighting (Guangzhou) Limited, Shanghai Branch
Office, Room 2609, Union Building, 100 Yanan Road East,
Shanghai 200002, China
Tel: (86) 21 6323 0800
Fax: (86) 21 6373 1626
E-mail: thornsha@public.sta.net.cn

Thorn Lighting (Guangzhou) Limited,
Beijing Branch Office, Room 519, China World Tower I,
China World Trade Centre, Beijing 100004, China
Tel: (86) 10 6505 4601
Fax: (86) 10 6505 4603
E-mail: thornbj@public.bta.net.cn

Czech Republic

Thorn Lighting CS, spol., Jaslenska 6, Praha 6,
160 00 Czech Republic
Tel: (42) 02 2431 5252
Fax: (42) 02 3332 6313
E-mail: thorn@thornlight.cz
Website: www.thornlight.cz

Denmark

Thorn & Jakobsson, Industrivej Vest 41,
DK-6600 Vejlen, Denmark
Tel: (45) 7696 3600
Fax: (45) 7696 3601
E-mail: thorn@jakobsson.dk
Website: www.thornjakobsson.dk

Estonia

Thorn Lighting Oy Eesti Filiaal, Laki 12-308,
10621 Tallinn, Estonia
Tel: (372) 656 3505
Fax: (372) 656 3227
E-mail: ando@thorn.ee

Finland

Thorn Lighting Oy, Airport Plaza Business Park,
Ayrilite 12A, 01510 Vantaa, Finland
Tel: (358) 9 549 222
Fax: (358) 9 549 22300
E-mail: asiakaspalvelu@thornlight.fi
Website: www.thornlight.fi

France

Thorn Europhane SA, 156 Boulevard Haussmann,
Cedex 08, Paris 75379, France
Tel: (33) 1 49 53 62 62
Fax: (33) 1 49 53 6240
Website: www.thorn.fr

Thorn Airfield Lighting, 156 Boulevard Haussmann,
75379 Paris Cedex 08, France
Tel: (33) 1 49 53 62 62
Fax: (33) 1 49 53 62 89
E-mail: thornairfield@thorn.fr
Website: www.thornairfield.com

Hong Kong

Thorn Lighting (Hong Kong) Limited, Unit 4301,
Level 43, Tower 1, Metroplaza, 223 Hing Fong Road,
Kwai Chung, N.T., Hong Kong
Tel: (852) 2578 4303
Fax: (852) 2887 0247
E-mail: info@thorn.com.hk
Website: www.thorn.com.hk

Thorn Lighting (HK) Ltd
Macau Branch, Room 306, 3/F Marina Gardens,
876 Avenida da Amizade, Macau, China
Tel: (853) 702 9711/702 972
Fax: (853) 702 970
E-mail: thorn@macau.cfm.net
Website: www.thorn.com.hk

Thorn Lighting CLK Ltd.
Airfield Lighting Division, Unit No.4301, Level 43,
Tower 1, Metroplaza, 223 Hing Fong Road,
Kwai Chung, New Territories, Hong Kong
Tel: (852) 2988 4128
Fax: (852) 2988 4139
E-mail: adminhk@thornclkaff.com.hk
Website: www.thornairfield.com

Hungary

Thorn Lighting Hungary Kft, West Gate Business Park,
Torokbalint, To Park H-2045, Hungary
Tel: (36) 23 501 570
Fax: (36) 23 418 120

Ireland

Thorn Lighting (Ireland) Limited,
320 Harold's Cross Road, Dublin 6W, Ireland
Tel: (353) 1 4922 877
Fax: (353) 1 4922 724
E-mail: enq.dublin@thornlight.com

Italy

Thorn Europhane Spa, Via G Di Vittorio, 2,
Cadriano di Granarolo, Bologna 40057, Italy
Tel: (39) 051 763391
Fax: (39) 051 763088
E-mail: info@thornlighting.it
Website: www.thornlighting.it

Latvia

Thorn Lighting Oy, Representative Office,
Skolas Street 21-216, Riga LV 1010, Latvia
Tel: (37) 7 332 660
Fax: (37) 7 332 660

Lithuania

Thorn Lighting Oy, Representative Office,
Kalvariju Street 1, Vilnius 09310, Lithuania
Tel: (370) 5 2 750 701
Fax: (370) 5 2 731 480

New Zealand

Thorn Lighting (NZ) Ltd, 399 Rosebank Road,
P O Box 71134, Rosebank, Auckland 7, New Zealand
Tel: (64) 9 828 7155
Fax: (64) 9 828 7591

Norway

Thorn Lighting AS, Industriveien 11, P O Box 63,
Skytta 1483, Norway
Tel: (47) 6706 2233
Fax: (47) 6706 0351
E-mail: s.kvernberg@thornlight.no

Poland

Thorn Lighting Polska Sp.z.o.o., Ul. Gazowa 26A,
Wroclaw 50-513, Poland
Tel: (48) 71 7833 740
Fax: (48) 71 3366 029
E-mail: thorn@thornlight.pl
Website: www.thornlight.pl

Russia

Thorn Lighting Oy, Park Place, Leninsky Prosp.,
113/1 Office D 110, Moscow 117198, Russia
Tel: (7) 095 956 59 39
Fax: (7) 095 956 59 40
E-mail: office.moscow@thorn.ru
Website: www.thorn.ru

Thorn Lighting Oy, Representative Office, Europa House,
1 Artilleriiskaya, St Petersburg 191104, Russia
Tel: (7) 812 118 8112
Fax: (7) 812 118 8119
E-mail: office.petersburg@thorn.ru
Website: www.thorn.ru

Singapore

Thorn Lighting (Singapore) Pte Ltd, 5 Kaki Bukit Crescent,
04-02 Koyotech Building, 416238 Singapore
Tel: (65) 6844 5800
Fax: (65) 6745 7707
E-mail: info@thornlight.com.sg
Website: www.thornlight.com.sg

Sweden

Thorn Lighting AB, Industrigatan, Box 305,
SE-261 23 Landskrona, Sweden
Tel: (46) 418 520 00
Fax: (46) 418 265 74
E-mail: thorn@thornlight.se
Website: www.thornlight.se

United Arab Emirates

Thorn Lighting Ltd Dubai, Al Shoala Building, Office 301,
Block E, PO Box 1200, Deira, Dubai, UAE
Tel: (971) 4 2940181
Fax: (971) 4 2948838
e-mail: lluae@emirates.net.ae

Thorn Gulf LLC, Al Shoala Building, Office 301/2,
Block E, PO Box 1200, Deira, Dubai, UAE
Tel: (971) 4 2948938
Fax: (971) 4 2948838
e-mail: thorn@emirates.net.ae

United Kingdom

Thorn Lighting Limited, Silver Screens, Elstree Way,
Borehamwood, Hertfordshire, WD6 1FE, UK
Tel: (44) 20 8732 9800
Fax: (44) 20 8732 9801
E-mail: brochures@thornlight.com
Website: www.thornlighting.co.uk

Thorn Airfield Lighting, Silver Screens, Elstree Way,
Borehamwood, Hertfordshire, WD6 1FE, UK
Tel: (44) 20 8732 9804
Fax: (44) 20 8732 9803
E-mail: airfield@thornlight.com or thornagluk@aol.com
Website: www.thornairfield.com

Export Sales

Thorn Lighting Limited, 156 Boulevard Haussmann,
Cedex 08, Paris 75379, France
Tel: (33) 1 49 53 6262
Fax: (33) 1 49 53 6240

Thorn Lighting Limited, Silver Screens, Elstree Way,
Borehamwood, Hertfordshire, WD6 1FE, UK
Tel: (44) 20 8732 9802
Fax: (44) 20 8732 9803
e-mail: international.sales@thornlight.com

www.thornlighting.com

Thorn Lighting is constantly developing and improving its products. All descriptions, illustrations, drawings and specifications in this publication present only general particulars and shall not form part of any contract. The right is reserved to change specifications without prior notification or public announcement. All goods supplied by the company are supplied subject to the company's General Conditions of Sale, a copy of which is available on request. All measurements are in millimetres and weights in kilograms unless otherwise stated.

Publication No: 347(INT) Publication Date: 2/05